



**INSTALLATION AND USER MANUAL
ENERGY GAS FIREPLACE**

**GAS FIREPLACE 70
GAS FIREPLACE 100
GAS FIREPLACE 150
GAS FIREPLACE 200**

Please read this manual carefully before installing and using the device and keep it in case you need any reference to it in the future. The manufacturer is not responsible for any material damage or physical injury caused due to incorrect installation and/or use of the device.



THERMIKI TSALIKIS company has a course of creative and successful activity with a duration of 40 years in the industry of oil and wood heater manufacturing. Along this path, the company constantly invests in the development of innovative technologies, is constantly informed about developments in the field and ensures that its products offer high aesthetics and quality that satisfy even the most demanding customers.

Continuous modernization, the application of the latest technologies that meet the needs of the market, immediate customer service, high organization and experienced staff, combined with the use of modern machinery, have made the company one of the most reliable on the market, enjoying the trust of its partners. The quality of the products it manufactures are distinguished by their ergonomics, functionality, durability, safety and simplicity of use, which is ensured through the careful selection of materials and the thorough control during the production process.

In the context of all the above, the company is also expanding its activity in the field of manufacturing gas heating devices, presenting the fireplaces of the GAS FIREPLACE series.

CONTENTS

SAFETY WARNINGS.....	4
INSTALLATION INSTRUCTIONS.....	6
Control system installation.....	7
Installation of receiver antenna.....	8
Connection to the gas supply.....	9
Liquid gas / Natural gas connection kit.....	10
Placement and adjustments of the control valve.....	10
Connection to the electricity supply	11
USE INSTRUCTIONS.....	13
First time use.....	13
Handling.....	13
Remote Control B6R-H9	14
Function activation	14
Instructions for use of remote control.....	15
DIAGRAMS - TABLES	22
TROUBLESHOOTING	24
WARRANTY	25

Product description

The gas fireplaces of the THERMIKI TSALIKIS GAS FIREPLACE series are heating devices with a closed combustion chamber, powered by gas. The device type is C11.

All models of the GAS FIREPLACE series and more specifically:

GAS FIREPLACE 70, GAS FIREPLACE 100, GAS FIREPLACE GAS FIREPLACE 150 and GAS FIREPLACE 200 are certified by the notified body ITEM Consult Ltd (1837).

The air fed into the combustion chamber is supplied from outside the building through a coaxial flue/air intake system (chimney). This eliminates the need for a vent grill or other opening to provide air for combustion, as is required in the case of open combustion chamber heaters. Such a solution provides the user with safety, because it prevents the passage of exhaust gasses directly into the space where the device is located, as well as comfort, because it prevents heat loss.

SAFETY WARNINGS



Carefully read the instructions provided in this manual before installing and using the device. Failure to comply with the installation and use instructions described in this manual makes the use of the device dangerous and voids its warranty. The manufacturer does not bear any responsibility for material damage or personal injury that may be caused by incorrect installation and use of the device.

- Installation of the appliance and all accessories required for its proper operation should ONLY be carried out by authorized technical personnel, certified for gas appliance installations.
- The installation of the appliance and all accessories required for its proper operation should be carried out in accordance with the applicable regulations and standards for gas appliances.
- ONLY certified components for use on gas connections should be used to install the appliance.
- Before installing the device, make sure that the gas and electricity supplies are turned off.
- Make sure that the gas and electricity supplies are in accordance with the operating specifications of the appliance.
- The device should be installed on level and stable ground.
- Install the device at a distance of at least 60cm from non-combustible structural elements (masonry), while the walls surrounding the device should be resistant to a temperature of at least 80°C.
- The connection should be connected to a grounded outlet for the power supply.
- Any modification of the device or its parts is prohibited.

- This device can be used by children aged 10 years and over and by people with reduced physical, sensory or mental capabilities, or lack of experience and knowledge, ONLY under supervision and having been instructed on how to use the device in a safe manner and with understanding of the possible risks during its use.
- Do not place objects, decorative or otherwise, on or inside the device.
- Do not pour water or any other liquid on the device.
- Do not store flammable or explosive materials in the area where the device is used. Fire/explosion hazard.
- Keep flammable materials and objects, such as furniture, curtains, carpets, etc. at least 1 meter away from the device.
- This device is intended for indoor heating. Any use other than that for which it is intended is prohibited.
- The accessible parts of the device are very hot during use and for some time after turned off. Keep children and pets away.
- If you find that the flame of the device goes out during use, turn off the device and wait at least 5 minutes before turning it on again.
- Any modification of the device or its parts is prohibited.
- It is forbidden to operate the device without installing the glass.
- If you notice damage to any part of the device or the installation, do not proceed with its use but contact your supplier immediately.
- The device is intended for space heating use through a gas fuel supply. Any use of a different fuel is prohibited.
- **IF YOU SMELL GAS:**
 1. Do not use any kind of flame and do not smoke.
 2. Do not use any electrical switch in the area.
 3. Turn off the gas and electricity supply immediately.
 4. Open doors and windows to the outside.
 5. If there is still a gas smell, leave the house, notify your neighbors and call the fire department and the gas service (if connected to natural gas).
 6. Do not re-enter the premises until authorities determine it is safe to do so.

INSTALLATION INSTRUCTIONS

To ensure the correct operation of the appliance, the installation of the fireplace should be carried out exclusively by qualified technical personnel with a certified license for installing gas appliances.

The fireplace is equipped with a safety system (FFD) that cuts off the gas supply to the burner in case the flame goes out during use, thus preventing uncontrolled gas leakage. Nevertheless, the installer is obliged to fit the appropriate fittings and safety valves in the gas connection to ensure the safe supply of gas to the appliance and the immediate interruption of its supply in the event of a leak. In the event that the above components are not installed for the safety and proper operation of the installation, the warranty of the device ceases to be valid.

The gas fireplace is designed to be connected to a special coaxial flue / air intake system (coaxial chimney), which allows the flame to be fed with atmospheric air and at the same time the flue gasses to be discharged to the outside of the building. Before proceeding with the use of the gas fireplace, the installer should:

- Carry out a leak test on the connections of the gas supply.
- To check the correctness of the connection to the electricity supply.
- To check the correctness of the chimney connection.
- To perform a test ignition and operation.
- To check the correct operation of all elements and fuses during the test operation.

Installation of a coaxial exhaust / air intake system

The coaxial ducts of the chimney can be inserted either through the wall or through the roof of the building, always in accordance with the current regulations. The maximum length of the chimney should not exceed 10 meters. You should also remember that a 90° angle is calculated as a 2 meter segment, while a 45° angle corresponds to a 1 meter long coaxial segment. See diagram one in the DIAGRAMS AND TABLES section for length and height calculation.

Ideally, the exit of the coaxial duct system to the outside should be made using a vertical duct 1 meter long, a 90° angle and a horizontal section up to 3 meters long to connect to a natural gas supply, while in the case of fireplaces powered by LPG gas, it is recommended that the length of the horizontal section not exceed 2 meters.

The connection between the device and the duct system should be sealed using high temperature silicone. When installing the duct system, the following should be taken into account:

- The regulations in force, taking into account the construction material of the masonry and the exit point of the terminal.
- In the case of flammable walls, ensure an additional distance of 5 centimeters between the wall and the outer surface of the coaxial duct. The remaining space must be covered with suitable thermal insulation that seals the building.
- If the duct passes through flammable walls, they must be protected by using heat-resistant insulation at a distance of at least 25 cm around the perimeter.
- The minimum height of the vertical part of the duct, from the point of connection with the fireplace, should be 1 meter.

- The different parts of the coaxial duct system should be connected to each other using special clamps that will ensure the stability of the connection and its tightness.

- If deemed necessary, the conductors of the coaxial system will must be stabilized using wall supports.

The coaxial ducts required for the exhaust / air intake system in the GAS FIREPLACE series, should have the following diameters:

Models 70, 100

- 150 mm the external duct that provides air intake to the combustion chamber,

- 100 mm the internal duct that ensures the discharge of exhaust gases.

Model 150

- 180 mm the external duct that provides air intake to the combustion chamber,

- 130 mm the internal duct that ensures the evacuation of exhaust gases.

Model 200

- 200 mm the external duct that provides the air intake to the combustion chamber,

- 130 mm the internal duct that ensures the discharge of exhaust gases.

In all cases, the installation of the coaxial duct system should be completed with a special terminal that allows the proper outflow of exhaust gases and the intake of air. All components to be installed must have the required approvals and CE certificates. A suitable condensate collector should be used to drain condensate likely to be generated during system use.

Control System Installation (Pre-Installed by the manufacturer)

The classic control system kit includes a Metrik Maxitrol GV60 control valve as well as a B6R-R8U receiver which has an antenna to ensure operation of the device with the remote control. The parts of the remote control system should be connected in a separate panel, which will be installed in an accessible place to allow possible repair or replacement of the individual parts of the system.

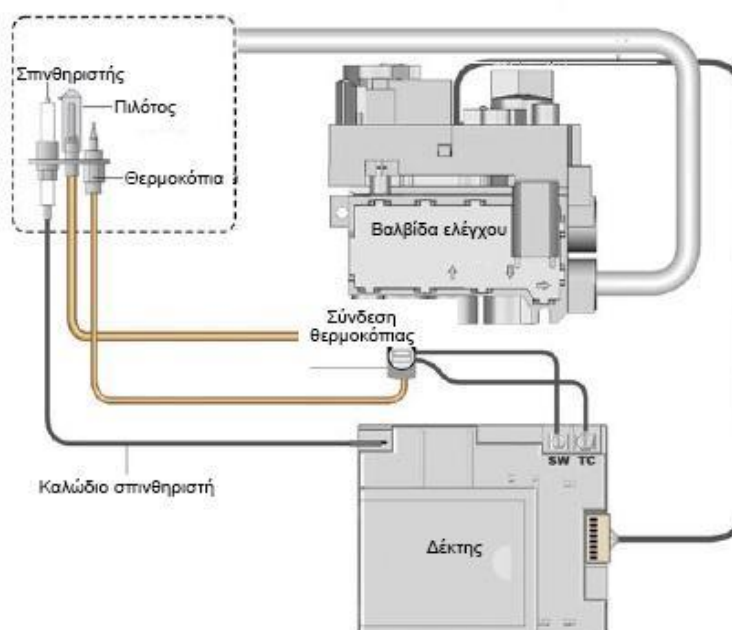

WARNING: Exposure of the electronic control system to temperatures above 60°C may cause irreparable damage to it. For the smooth operation of the control system, make sure that it will be installed in a room where the temperature does not exceed 25°C.

WARNING: The installation of the control system must be done exclusively in factory settings. Do not connect the device to a power supply until the installation is complete.

WARNING: Installation of the control system should be performed in accordance with the instructions and diagrams found in this manual.

The maximum distance between the control panel and the gas fireplace depends on the length of the cables connecting the GV60 gas controller to the ignition electrode and the combustion sensor (thermocouples). Do not connect extensions to the cables supplied with the device as this may affect the proper operation of the control system. Do not place the ignition system cable too close to metal parts. Make sure the ignition wire does not come into contact with the receiver housing. All parts of the system should be protected from moisture, dust and, in general, from factors that lead to the formation of corrosion.

The series of gas fireplaces can only work with the control system of gas supplied with the device. **In the event that the replacement of individual components of the system is required, only the original spare parts of the manufacturer should be used. The manufacturer is not responsible for any damage caused by the use of non-approved spare parts.** The plugs for connecting the cables are selected in such a way as to avoid their incorrect connection.

Installation of receiver

The antenna is part of the system that connects directly to the B6R-R8U gas remote control receiver. Allows wireless control of the fireplace operation using a remote control. When connecting the control system, take special care not to install the antenna too close to the ignition wire.

Gas System Technical Specifications Table

IN ACCORDANCE WITH	2009/142/EEC 305/2011, 2016/426, 2014/30, 2014/35
GAS TYPE	G20, G30, G31
GAS REGULATOR PRESSURE	20 mbar (G20) / 28-37mbar (G30,31)
MAXIMUM INLET PRESSURE	50 mbar
IGNITION	Electronic ignitor
GAS INLET / OUTLET	Bottom and side of gas valve
MAIN GAS CONNECTION	1/2'' to 3/8'' contraction
GAS EXHAUST TYPE	C11
GAS VALVE OPERATION TEMPERATURE	0 °C to 80 °C

Gas supply connection

WARNING: The connection of the device to the gas supply should **ONLY** be carried out by qualified and licensed technical personnel. Make sure that the appliance is disconnected from the gas and electricity supplies during work on the connection to the gas supply.

WARNING: Any use of flame is prohibited during the installation process of the fireplace as well as when checking for leaks. Failure to comply with this directive. may cause a fire or explosion, resulting in serious property damage, personal injury or even death.

WARNING: The selection of the appropriate nozzle (injector) for the supply of gas to the burner should be made according to the type of gas that will be used as fuel (natural gas or liquid gas). You should contact the manufacturer or their dealer to fit the burner to the nozzle for the correct type of gas.

The main burner unit used in the GAS FIREPLACE series gas fireplaces consists of two parts connected together by the outlet of the GV60 gas flow control valve. **The connection of the valve to the burner and the pilot is carried out by the manufacturer.** If required, to connect the burner or pilot to the automatic gas control valve, you must first disassemble the front glass and remove the metal part located above the main burner position. For the passage of the individual cables through the casing of the gas fireplace, special attention must be paid to how to protect them from high temperatures. This is done with the help of special casings, resistant to high temperatures. The remaining parts of the installation must be sealed with high temperature silicone.

Make sure that the device is adapted to be connected according to the type of gas of the particular supply. All the necessary information about the required gas parameters can be found on the display panel. Before connecting the gas supply pipes, it is necessary to clean and remove metal filings and other impurities from inside them. The automatic gas valve should be protected from moisture and dust. These factors can cause irreparable damage to system parts. The interruption / restoration of the gas supply to the device. should be ensured by installing a ½ inch diameter gas check valve in the supply pipe. Do not use Teflon to seal gas connections. If the gas installation requires it, connect a special filter to protect the valve from contaminants that may be in the gas supply.

WARNING: it is necessary to install a gas leak detector and connect it to a safety solenoid valve able to stop the gas flow in the gas supply installation. This will ensure automatic shut-off of the gas supply in the event of a leak.

LIQUID GAS / NATURAL GAS CONNECTION KIT

To connect the fireplace to a LPG supply, it is necessary to use the following kit or its parts in the correct arrangement to ensure correct operating pressure and safety use of the device. The gas supply in this kit is from the right (red arrow, flexible connection pipe to the LPG supply) to the left (green arrow, spiral connection to the device). It is mandatory to install two pressure regulators, i.e. a first stage high regulator pressure (H/P) and a second stage low pressure regulator (L/P). The installation of the following components must be carried out by a qualified technician and is **MANDATORY** for the validity of the manufacturer's warranty.

Note: The following components are part of the gas supply installation and not are considered parts of the device. The manufacturer is not responsible in the event of an error installation or use of incorrect or defective parts.

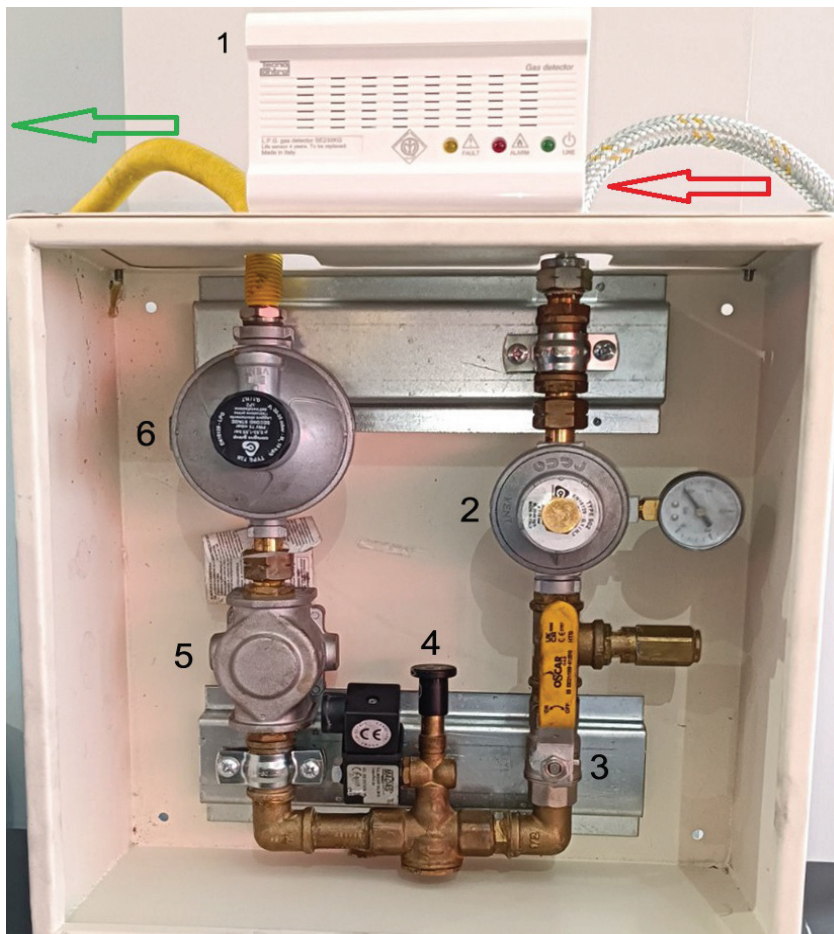

1. Leak detector (*)
2. First stage regulator H/P
3. ON/OFF valve
4. Electrovalve
5. Gas filter
6. Second stage regulator L/P

For the connection to a natural gas supply, the components that must be used are the leak detector, the ON/OFF gas valve and the electrovalve.

(*) **CAUTION:** The leak detector is placed at a low point (30-40cm from the floor or lowest point at which the lining closes) in gas connections and at a high point (30-40 cm from ceiling or the highest point at which the lining closes) to natural gas connections.

Control valve description and settings. The picture below shows the GV60 control valve in the correct position with the switches at the top and the connections at the bottom. The valve cannot be installed upside down. The valve can be placed at an angle from 0° to 90° in relation to the indicated position (also vertically). You should remember that all unused gas inlets and outlets should be sealed with suitable caps.

1. Control switch
2. Manual operation
3. Outlet pressure adjustment screw
4. Gas outlet
5. Gas inlet
6. Thermocouple (FFD) connection
7. Low flame setting
8. Operating pressure measurement
9. Inlet pressure measurement

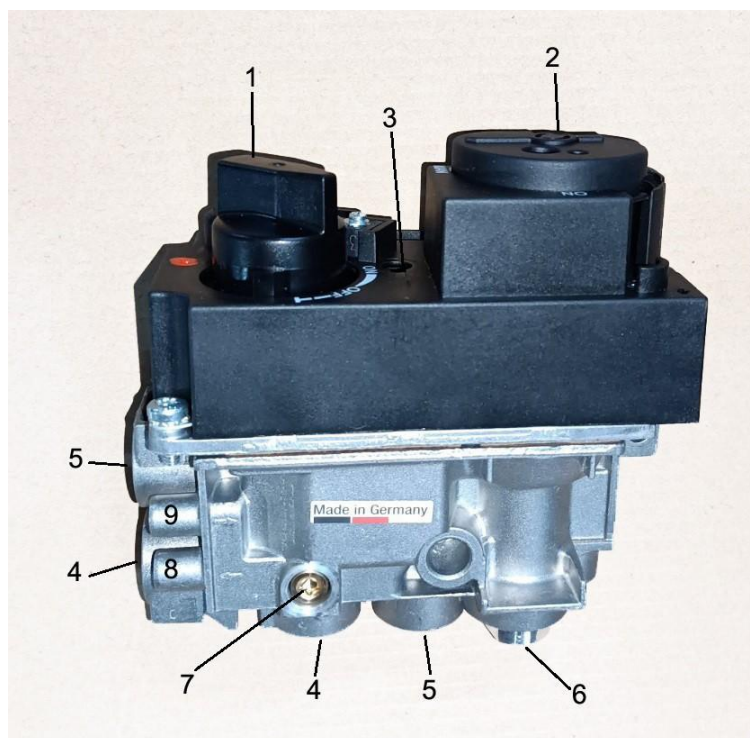

Adjusting the height of the pilot flame

The pilot flame height is factory set to the maximum point and requires no further adjustment. The thermopile head should be close enough to the pilot that the flame covers the top of it.

Adjustment of the GV60 control valve according to gas type.

The control valve can be adjusted in order to operate on different types of gas (Natural gas and LPG). The adjustment of the operating pressure (outlet) and the minimum intensity (low flame) are performed according to the instructions below.

Setting the outlet pressure (high flame pressure)

1. Connect the manometer to the operating pressure measurement point (8), after removing the cap (if present) and unscrewing the screw 3-4 turns.
2. Turn on the device with the remote control. The valve after activation will automatically turn to maximum power.
3. The pressure adjustment screw (3) is located on the upper part of the valve, between the two switches, as you can see in the picture above. If there is a seal, remove it.
4. Adjust the regulator screw to set the desired value of the main burner pressure (high flame), depending on the model. To decrease the pressure, turn the adjusting screw clockwise, to increase it, turn the screw counter-clockwise.

5. After adjusting the pressure, disconnect the pressure gauge, secure the regulator screw and install the cap.

If, despite the adjustment, the desired pressure is not reached, check the inlet pressure (9) from the corresponding check point.

If the inlet pressure is within normal limits contact the manufacturer. Otherwise, you should take the necessary measures to ensure the correct pressure in the gas supply and then adjust the output pressure again.

Low flame setting (minimum flame height) of the main burner

To adjust low flame pressure, follow this procedure:

1. Turn the control switch (1) to the “OFF” position. Then turn on the device with the remote control. The valve after activation will automatically turn to maximum volume.
2. Lower the flame intensity gradually, until you reach the last step before the burner flame goes out completely.
2. The minimum flame height of the main burner can be adjusted through the adjustment screw (allen), as shown in the figure below.
3. Turn the screw clockwise to decrease and counter-clockwise to increase the pressure.

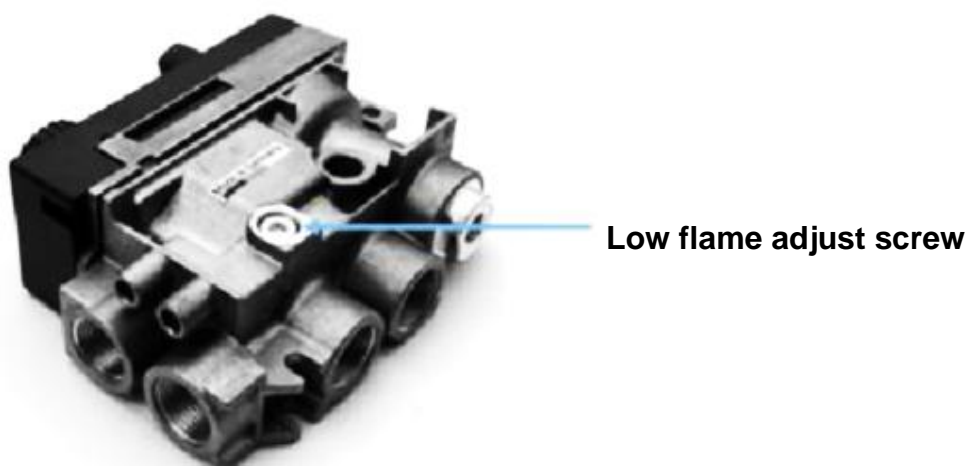

Sealing check

After connecting the system to the gas supply, the tightness of the connections must be checked using a special sensor. If a leak occurs, turn off the gas supply and repeat the steps related to the installation of the individual parts of the system, paying particular attention to the point where the leak occurred.

Connection to the power supply

Connect the appliance to the electrical supply only after the installation of the coaxial duct system as well as all parts of the gas supply system has been completed. The device is connected to a 220V - 50Hz supply, in an installation with grounding. Special care must be taken that the wiring connecting the control valve to the receiver does not pass through the hot parts of the fireplace.

Cladding

WARNING: If the device is lined with structural material (e.g. plasterboard), an opening of at least 50x50 cm must be provided for direct access to the connections of the gas control valve and the electrical connection. Do not proceed with the appliance cladding before all connection works and gas valve adjustments are completed.

WARNING: If the device is lined with construction material (e.g. plasterboard), this lining should have a permanent ventilation opening in the upper part, either towards the place where the device is installed or towards an outside area, with an area of at least 150 m².

Before proceeding with the installation of the lining, you should ensure that the control valve of the device is protected from dust and dirt. The fireplace lining should be made of non-combustible materials (including the floor and ceiling) in accordance with the applicable building regulations. Depending on the type of gas, the air exhaust grille should also be placed: under the roof in connection with a natural gas (NG) supply, and low, slightly above the floor in connection with a LPG supply.

Glass disassembly

WARNING: Before removing the glass, make sure the appliance is not in operation, is cool and disconnected from the gas and electricity supply. The disassembly of the glass should be carried out by qualified technical personnel.

The device is equipped with a fire-resistant glass resistant to temperatures up to 800°C. To replace it, you must first remove the perforated rails around the perimeter and then the support rails, starting from the sides. To remove the side rails, unscrew the screws located at the far right and left of the top frame. Then unscrew the remaining screws holding the top and bottom metallic profiles together to release the glass. Depending on the model of the GAS FIREPLACE series, the method of disassembling the glass may differ slightly from that described above.

Installation of decorative elements

WARNING: Placing flammable materials inside the device is prohibited.

The manufacturer recommends the use of the decorative elements provided optionally with the device. The manufacturer is not responsible for possible damages that may be caused by the use of decorative elements other than those provided. The decorative elements are made of non-flammable materials. To install the decorative elements it is necessary to disassemble the front glass, as described in the corresponding paragraph of the manual. The elements must be placed in such a way that they do not cover the pilot flame as well as the ventilation holes of the central burner, which may affect the correct operation of the device. The main burner of the fireplace is equipped with spacers that facilitate the correct placement of the decorative elements. The distribution of elements in the combustion chamber of the device should allow the free flow of air around the main burner and the control flame. The ceramic elements should not be in contact with the glass.

USE INSTRUCTIONS

First time use

Before turning on the fireplace for the first time, you must make sure that all connections of the individual parts of the system have been made according to the installation instructions in this manual. Incorrect installation can cause operational problems and endanger the environment and the user. During the first couple of hours of operation, the fireplace may emit an unpleasant smell and smoke. This is due to the factory paint burning off. Keep children and pets away during the first start-up. To speed up the paint burning process, the fireplace should be heated for a few hours by setting the flame to maximum intensity. If during the first burning the inner surface of the glass is clouded by smoke, it should be cleaned using a special glass cleaner for fireplaces. Make sure the area is adequately ventilated during the first start-up.

When heating with gas you may notice spotting on the wall and ceiling. This is caused by the upward movement of warm air which carries away the dust particles. A solution to this problem is to periodically ventilate the space where the gas fireplace is located. If the fireplace has been installed in a newly built space, you should wait at least 6 weeks before the first activation, so that the moisture found on the walls, floor and ceiling has been removed.

Control

The fireplaces of the GAS FIREPLACE series are controlled wirelessly using a remote control, in which 2 AAA batteries are placed. The fireplace starts automatically with the ON-OFF button on the remote control. If the pilot flame does not ignite after 4-5 attempts, shut off the gas supply immediately and contact the service technician. If the device does not receive any command from the user within six hours, the automatic gas control system reduces the flame of the main burner to a minimum. In case of continuous operation of the fireplace without the intervention of the user, the system deactivates the device and cuts off the gas supply after five days from the last registration of the settings. Before the batteries in the receiver are fully discharged, the control valve automatically shuts off the gas supply.

Using the remote control B6R-H9

WARNING: The remote control should be kept away from children and people who do not fully understand the use of the device and potential dangers during its use. In order to be able to operate the gas fireplace using the remote control, you must make sure that the gas supply to the device is open.

Note: The B6R-H9 remote control has a built-in temperature sensor that is used as a thermostat. Through this, the room temperature is measured and compared with the temperature set on the thermostat by the user. The device should be placed in an area that ensures the correct measurement of the room temperature, in order to exclude any errors due to incorrect measurement e.g. due to exposure to sunlight or placing near a device that emits heat.

Note: The manufacturer supplies the fireplace with the remote control already activated. Make sure the gas valve switches are in the ON position before ignition.

The GAS FIREPLACE series uses the latest technology remote control type B6R-H9 set according to the European standard for radio frequencies at 868MHz. The remote control provided with the fireplace requires coordination with the receiver of the device before its operation. To do this, you must first, using a thin-bladed screwdriver, press and hold the RESET button located on the receiver box, until you hear two characteristic beeps, and then release. Then you should press and hold the button  on the remote control until you hear two short beeps indicating the synchronization of the remote control with the receiver. A long beep informs that the system components have not been tuned and you must repeat the process.



Enable remote control function (pre-installed by manufacturer)

Install the batteries. All available icons will appear on the screen and start flashing. Press the button corresponding to the desired function and hold it for 10 seconds. The icon corresponding to the selected key will flash, until the end of the activation process. The icon corresponding to the selected function will appear on the remote control screen.



Note: When starting for the first time, or after the gas supply has been cut off and reconnected, or after a long period of disuse, 3-4 starting attempts may be required. However, if the device still does not light up, turn off the gas supply and contact your supplier's service department.

WARNING: if the pilot flame turns off immediately or after a few seconds, wait at least 3 minutes before trying to turn on the device again.

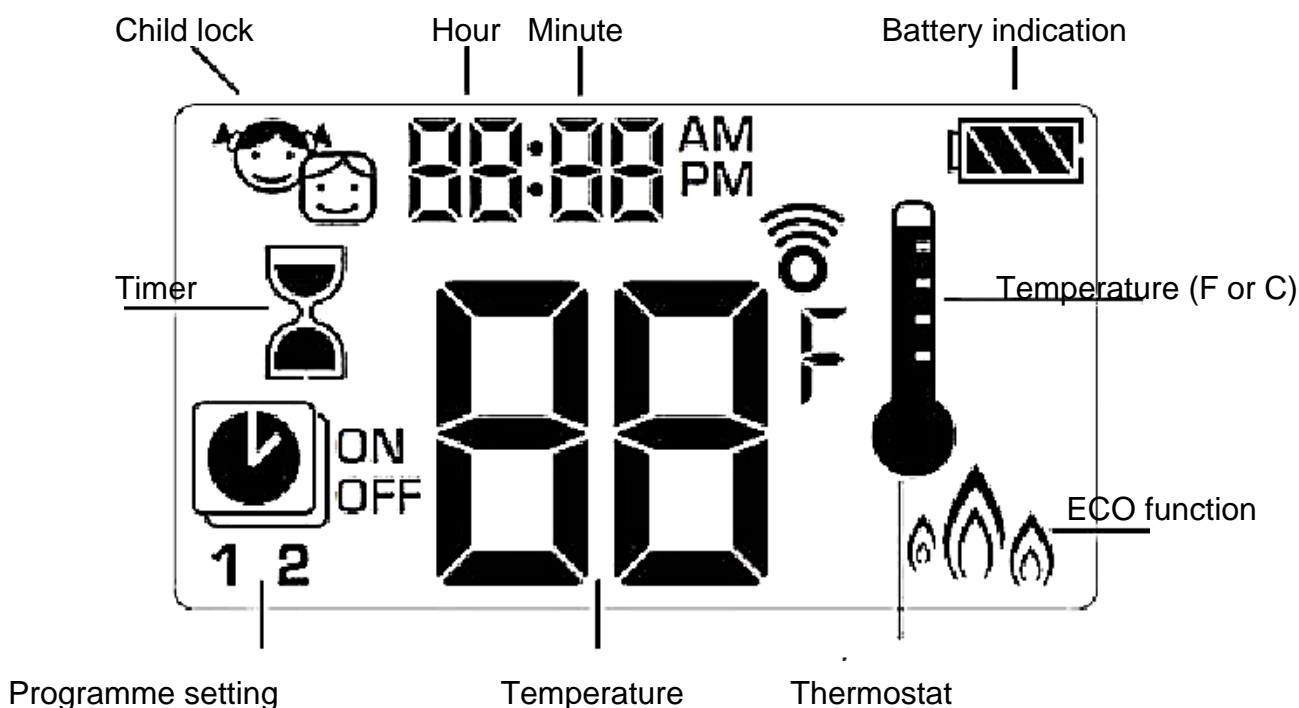
Remote control symbols and adjustments



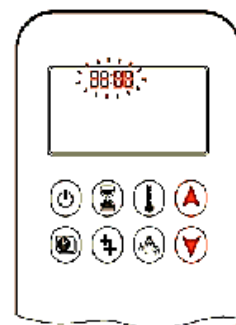

Ρύθμιση ημέρας και ώρας

1. To be able to set the day of the week press the  and  keys.
2. Press up or down arrows to select the number corresponding to the day of the week (1 – 7 respectively for Monday-Sunday)
3. Press the up and down arrow keys at the same time. The time will start flashing.
4. Set the time with the up or down arrow.
5. Press the up and down arrow keys at the same time. The minutes will begin to be flashing.
6. Set the minutes using the up or down arrow.
7. To confirm the setting press the same keys at the same time or wait.



Ρυθμίσεις θερμοκρασίας

To change the temperature unit, press the  and  keys at the same time. The user can choose between Celsius and Fahrenheit. Selecting °F (Fahrenheit) automatically sets the clock to 12-hour format and selecting °C (Celsius) sets the clock to 24-hour format.



Turning ON and OFF the device (default settings)

1. Press the  button until you hear two short beeps. The start of the ignition process is confirmed by the display of a flashing burner icon on the screen, at which point you should release the button.
2. Ignition of the pilot flame is confirmed by a single signal.
3. After lighting the main burner the remote control switches automatically in manual mode.

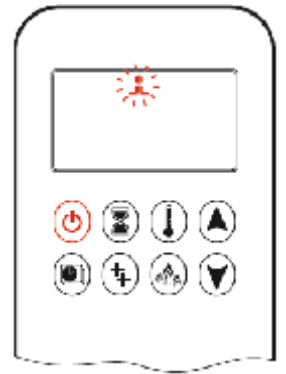
CAUTION: If after a few ignition attempts the pilot does not ignite you should set the main valve switch to the OFF position and refer to the "TROUBLESHOOTING" section



Standby and power off

- To put the device in standby mode you should press and hold the  button until the main burner turns off.
- To turn off the device, you must press . The pilot flame will go out. Before attempting to light the fireplace again, you should wait at least 5 seconds.





Flame height adjustment (maximum, minimum, middle)

- To adjust the flame of the main burner to the minimum height, you must press the down arrow key twice. The display will show LO.
- To increase the flame of the burner to the maximum value, you must press the up arrow key twice. The display will show HI.
- To increase the flame height to any intermediate intensity, you must press and hold the up arrow key until the desired setting.
- To reduce the height of the flame, as well as to put the fireplace in standby mode, you should press and hold the down arrow key.



Auto-off timer

1. Press and hold the  button until the corresponding icon appears and the time indicator starts flashing.
2. Enter a value using the up and down arrow.
3. To confirm press the  key. The minute display will start flashing.
4. Enter a value using the up and down arrow.
5. To confirm press the  key or wait.

After the end of the time you set on the timer, the burner will turn off. The maximum countdown time value you can set is 9 hours and 55 minutes.



To cancel the auto-off timer, press the same button.

The icon along with the countdown time indicator will stop showing.



Thermostat function

Through the thermostat function, the temperature in the room is compared to the temperature you have set as the thermostat value. The height of the flame is automatically adjusted so that the temperature chosen by you is reached in the room.

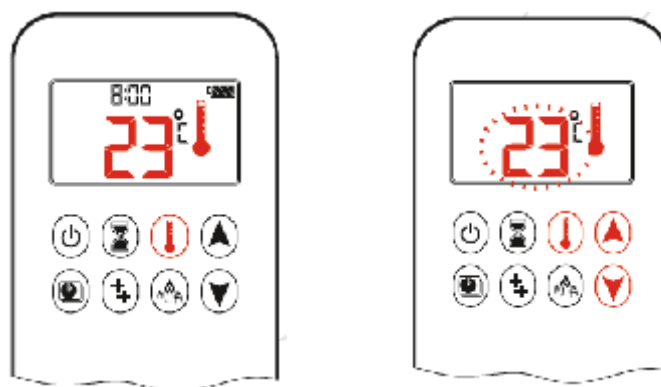

To activate the thermostat, press the  key. The corresponding icon will appear on the screen, as well as initially the temperature set by you and then the current temperature in the room. To set the temperature, press and hold the  key until the corresponding icon appears on the screen. Once the temperature indicator starts flashing, you can set the desired value by pressing the up and down arrows to increase or decrease it respectively. To confirm the temperature value you set, press the  key or wait.

To deactivate the thermostat, press the same button and then up or down arrow.



Automatic on / off programming function

With the programming function, you can choose the time of automatic activation and deactivation of the fireplace for each day of the week and at a specified temperature. You can set up to 2 different programs.



- To activate the programming function, press the  key. The icon will appear on the screen, as well as the indications 1 or 2 and ON or OFF.
- To deactivate the programming mode, press the  key or the up or down arrow to switch to manual mode.



Temperature, date and time settings for programming mode

Note: Adjusting the temperature for the thermostat function simultaneously sets the temperature value for the programming function. If no thermostat is set, then the default switch-on temperature is set to 21°C and switch-off temperature is not set (only the pilot flame will be on).

To adjust the temperature:



- Press and hold the  key until the corresponding flashing icon appears on the screen. ON will be displayed as well as the switch-on temperature (set according to the value you set for the thermostat).
- Press the  key or wait. The corresponding icon and the word OFF will appear on the screen and the value defined as the shutdown temperature will start flashing, which you can adjust with the up and down arrows.
- To confirm press  and continue with setting the days.

To set the date:

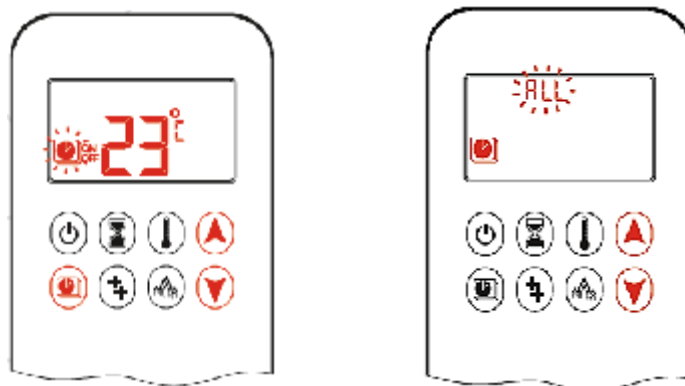
- ALL will start flashing on the display. Press the up or down arrow to select one of the three available options (ALL, SA:SU, 1, 2, 3, 4, 5, 6, 7). The SA:SU option corresponds to Saturday and Sunday. The numbers 1-7 correspond to the days of the week (from 1=Monday to 7=Sunday).
- To confirm press  and continue with setting the time.







Setting the activation time (Program 1)

- The icon  and the indicators 1 and ON will appear on the screen. Then the display will momentarily show the display with the day selection (e.g. ALL) and the time display will start flashing.
- Set the desired time using the up and down arrow.
- To confirm press . The icon and indicators 1 and ON will appear on the screen and momentarily the indicator with the selection of the day (eg ALL). Then the minutes field will start flashing.
- Adjust the minutes using the up and down arrow.
- To confirm press  and continue with setting the switch-off time.





Setting the OFF time (Program 1)

- The icon  and the indications 1 and OFF will appear on the screen. Then the display will momentarily show the  icon with the day selection (eg ALL) and the time display will start flashing.
- Enter the time using the up and down arrows.
- To confirm press . The time icon and the indications 1 and OFF" will appear on the screen and then the indication with the day selection (eg ALL) will briefly appear again. Then the minutes field will start flashing.
- Adjust the minutes using the up and down arrows.
- To confirm press .

Note: After setting the time for program 1, you can enter the on and off time settings for Program 2. Otherwise, Program 2 will remain inactive.



- The temperature and on and off time settings for Programs 1 and 2 are exactly the same for all day options (ALL, SA:SU, 1, 2, 3, 4, 5, 6, 7). Entering new temperature settings automatically adjusts the values set as default. To restore the factory settings for Programs 1 and 2, you must restart the remote control by removing the batteries.

Eco function

The flame height alternates between minimum and maximum. When the room temperature is lower than the value selected on the thermostat, then the flame height remains at maximum. If the temperature in the room is higher than that set, then the flame height remains at a minimum. One Eco mode cycle takes about 20 minutes. To activate the Eco function, press the  key and the corresponding indicator will appear on the screen. To deactivate the Eco mode, press the  key and the corresponding indicator will stop appearing.



Key protection (child lock)

- To activate the key lock function press at the same time keys  and . The corresponding indicator will appear on the screen.
- To disable the key lock function, press the same keys at the same time. The corresponding indication will stop appearing on the screen.



Battery replacement

Used batteries in the remote control can overheat, leak or even explode. Do not use batteries in the device that have been exposed to sunlight, moisture, high temperatures and vibrations. Only install batteries of the same type and manufacturer. Do not insert new batteries together with used ones. The remote control is powered by two AAA size batteries. The life of the batteries is estimated approximately in use for one heating season. The manufacturer of the device recommends the use of alkaline batteries due to the reduced risk of use and better performance. The use of rechargeable batteries is also allowed. When removing batteries, do not use tools that may cause a short circuit. Replacing batteries using conductive objects may cause permanent damage to the remote control and receiver electronics.

Replacing batteries in the remote control:

- Remove the cover on the back of the remote control.
- Carefully remove the used AAA batteries from the remote control.
- Insert the new AAA batteries paying attention to the polarity (+/-)
- Re-install the cover on the back of the remote control

Batteries should not be disposed of with other household waste. Dispose of the batteries in the special battery recycling bins.

Maintenance and cleaning of the device

WARNING: All maintenance and cleaning operations should ONLY be carried out by qualified technical personnel and after we have closed the gas flow and the electricity supply and made sure that the fireplace is cold and not in operation.

- Periodic control of the device should be carried out once a year or sooner if deemed necessary due to use.
- Cleaning and maintenance of the coaxial duct system (chimney) must be carried out at least once a year.
- If you notice that the glass is damaged, such as cracks or scratches, it must be replaced immediately with a new one.
- Any modification of the device and its individual parts is prohibited.
- Do not use corrosive products to clean the device.
- In case of replacement of individual parts, you should only use certified spare parts, according to the manufacturer's instructions.

CHECK LIST

1) General control.

When performing a general check, check the following:

Ignition procedure, correct operation of all safety systems of the installation and device, stability of pilot flame, stability and uniformity of burner flame, remote control batteries, correct operation of all programs of the remote control.

2) Glass control

Check: If there is damage, the correct fit to the body of the fireplace, the condition of the sealing thread, the cleanliness of the glass surface.

3) Checking the connection table

Check: The tightness of the gas connections, proper ventilation, if there is damage to the connection cables, if the cables are protected from high temperatures, protection of the panel from moisture.

4) Check combustion chamber

Check: The decorative elements do not cover the burner, the correct distance of the thermocouple from the pilot flame, cleanliness of the combustion chamber, cleanliness of the ventilation holes, tightness of the chamber, if there is any kind of damage.

5) Checking the coaxial duct system (chimney)

Check: The tightness of the system, the free inflow of air / outflow of exhaust gases from the coaxial chimney system.

6) Control system control

Check: The condition of the receiver antenna, the correct operation of the control valve switch, the condition of the insulations, the condition of the power cable, the protection of the control system from overheating

7) Control of lining and decorative elements

Check: The condition of the lining material, the correct and safe distance of materials and objects from the fireplace, the condition of the decorative elements and whether they have suffered damage, whether the decorative elements are in contact with the glass, the correct placement of suitable openings to access the parts of the device.

DIAGRAMS - TABLES

1. Chimney maximum length and height diagram

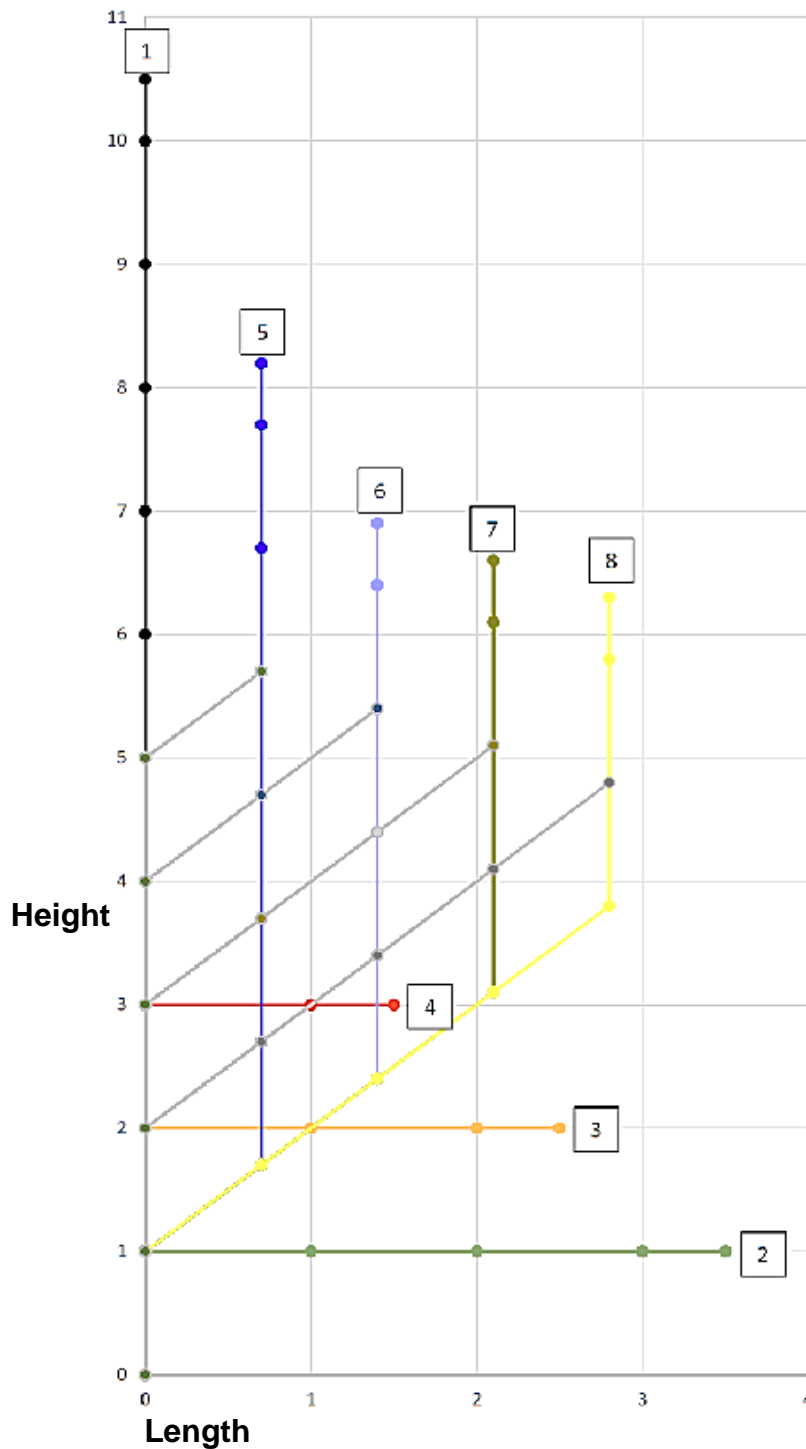

(0,0) Device.

1-8: chimney installation methods. Example: for device 8, 1m vertical flue, 3m diagonally upward and 2m vertically were used.

Indicative cladding / built-in design

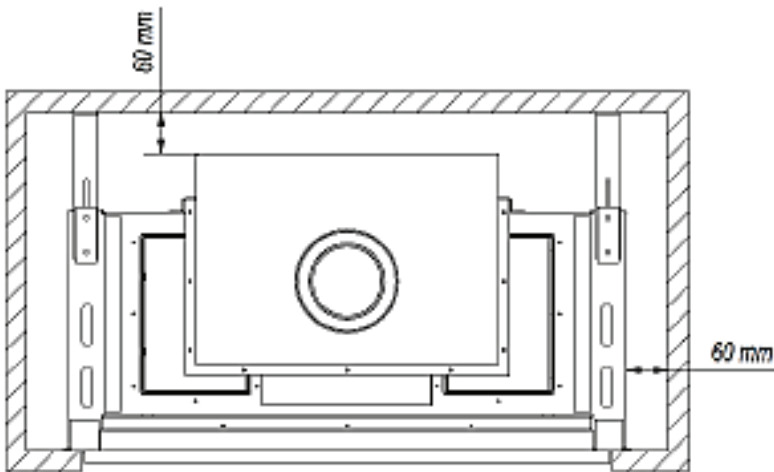

Installation of the device should only be done with insulating material, keeping a distance of 6cm from each fixed point and removing the flaps where deemed necessary by the manufacturer, depending on the route of the chimney.

TROUBLESHOOTING

PROBLEM	POTENTIAL SOLUTION
The device does not turn on (absence of beep sound confirming the ignition process)	Change the batteries in the remote control. Check the correct power supply to the device. Reboot the receiver (RESET). Check the condition of the antenna.
No voltage at the gas control valve	Check the condition of the wire on the gas valve. If any component of the gas valve does not work (coil, control switches, etc.) contact the manufacturer immediately to replace the valve.
Absence of spark at ignition electrode (spark plug)	Check the wire connection between the receiver and the spark plug. Check the condition of the spark plug and its wire. Check the electrical connection of the device. Reset the receiver. Add a ground wire between the valve and the pilot
Pilot flame does not ignite	Check that the gas supply valve is open. Check that the gas control valve switches are ON Try starting again if the fireplace has been deactivated for a long time. Check the pressure in the gas supply. Check the receiver connections.
Continued sparking after pilot ignition	Check the gas valve connection wires. Check the receiver connections
Pilot flame goes out immediately after ignition or is too low	Check the connection and correct operation of the thermocouple connected to the gas control unit Check that the pilot flame is in the correct position and is heating the thermocouple. Check the condition of the gas valve. Check gas inlet and operating (outlet) pressure. Check that the pilot nozzle is clean.
Main burner does not ignite	Check that the burner ventilation openings are clean. Check that the gas valve manual switch is in the ON position. Check pilot flame. Check the condition and connection of the thermocouple and whether the pilot flame is heating it.
The burner turns off suddenly	Check the thermostat settings. Check the condition in the coaxial chimney system. Check pilot flame.
Glass smoke is created after a period of use	Check that the gas pressure in the system is correct. Check that the burner holes are clean. Check that the gas regulator is installed correctly. Check the condition in the coaxial chimney system.
The device does not turn off using the remote control	Turn off the gas supply to deactivate and then: Check the remote control batteries. Check the receiver connections.

In the event of a problem that is not listed in the table above or in the event that the problem persists, cut off the gas supply to the device and immediately contact the authorized service.

WARRANTY

The manufacturer guarantees the excellent quality of the products and their smooth operation. In case you detect any manufacturing defect or malfunction, the manufacturer undertakes to immediately proceed with the required actions for their restoration.

- The product warranty is valid for one (1) year from the date of purchase regardless of the date of installation.
- For the electrical parts of the product, the warranty is valid for one (1) year.
- The combustion chamber glass is not covered by the warranty.
- The purchase receipt must be kept throughout the warranty period in order to prove the date of purchase.

Terms and conditions of the warranty

This warranty is valid only if:

- The product has been installed and used in accordance with the installation and use instructions of this manual.
- The product has been connected to the chimney correctly and in accordance with the applicable regulations and standards.
- The product has not been damaged by external factors (e.g. impact during transport) and has not been modified or mishandled.

The cost of the fireplace lining and transportation to and from the company's headquarters is borne by the customer.

For more information and clarifications, you can contact the manufacturer or your supplier